

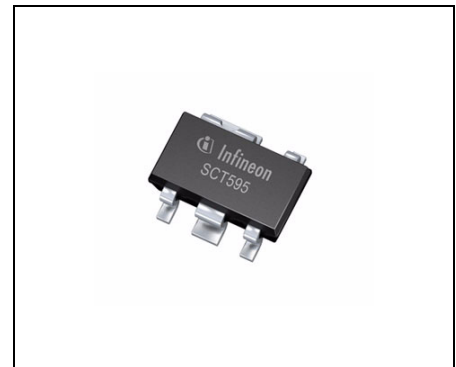

### Features

- 15 mA output current capability
- 1  $\mu$ A current consumption in standby mode
- Low quiescent current consumption  
60  $\mu$ A in ON mode
- Inhibit input
- Very small SMD-Package PG-SCT-595-5
- Wide operation range: 6.2 V to 42 V
- Wide temperature range: -40 °C to 150 °C
- Output protected against short circuit
- Overtemperature protection
- Green product (RoHS compliant)
- AEC qualified.



PG-SCT-595-5

### Functional Description

The **TLE 4286 G** is a 5-V low-drop fixed voltage regulator in the very small SMD package PG-SCT-595-5. The maximum input voltage is 42 V. The output is able to drive a load of more than 10 mA while it regulates the output voltage within a 4% accuracy.

The device can be switched in stand-by mode via an inhibit input which causes the current consumption to drop below 1  $\mu$ A.

A temperature protection disables the IC at over temperature.

Type	Package	Marking
TLE 4286 G	PG-SCT-595-5	A1

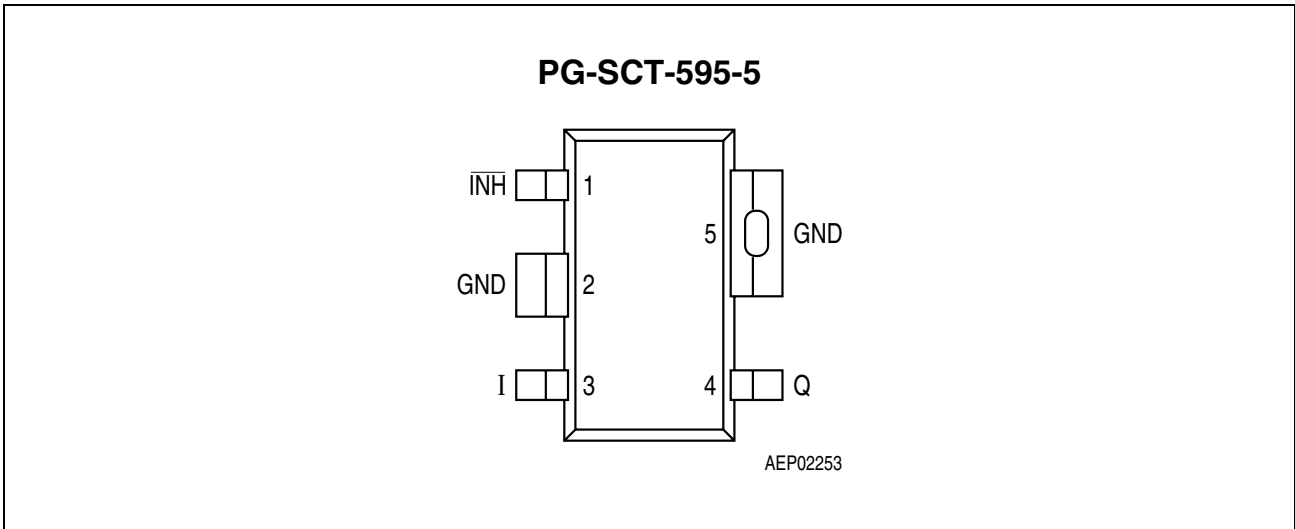

**Figure 1** Pin Configuration (top view)

**Table 1** Pin Definitions and Functions

Pin No.	Symbol	Function
1	INH	<b>Inhibit input;</b> H for active ( $V_Q = 5\text{ V}$ ) and L for stand-by
2	GND	<b>Ground;</b> internally connected to pin 5
3	I	<b>Input voltage</b>
4	Q	<b>Output voltage;</b> must be blocked by a capacitor $C_Q \geq 1\ \mu\text{F}$ , $\text{ESR} \leq 10\ \Omega$ to GND
5	GND	<b>Ground;</b> internally connected to pin 2

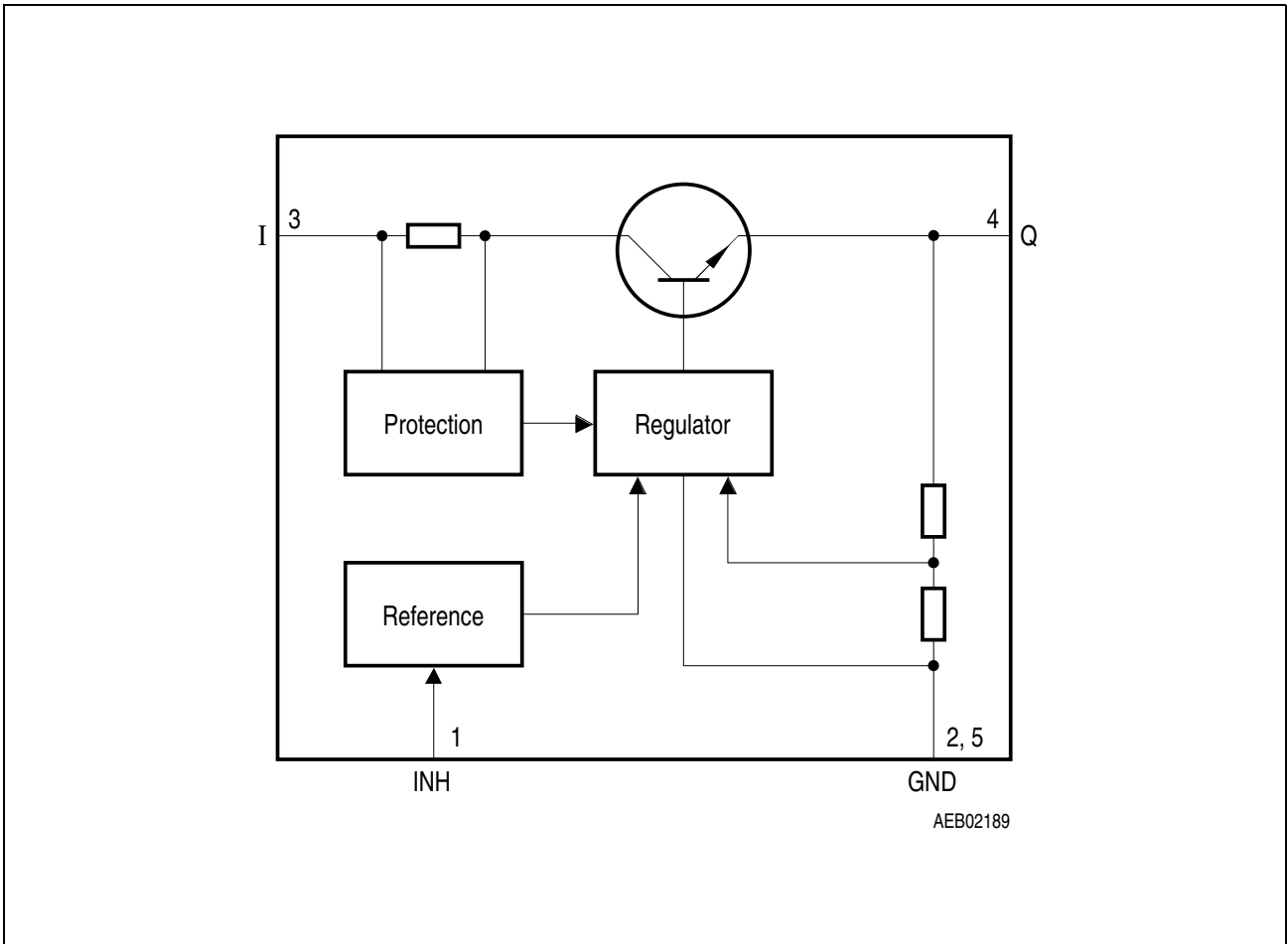

**Figure 2**      **Block Diagram**

**Table 2 Absolute Maximum Ratings**
 $-40\text{ °C} < T_j < 150\text{ °C}$ 

Parameter	Symbol	Limit Values		Unit	Remarks
		Min.	Max.		
<b>Input</b>					
Voltage	$V_I$	-0.3	45	V	–
Current	$I_I$	-20	*	mA	* internally limited
<b>Output</b>					
Voltage	$V_Q$	-0.3	16	V	–
Current	$I_Q$	-20	*	mA	* internally limited
<b>Inhibit</b>					
Voltage	$V_{INH}$	-40	45	V	–
Current	$I_{INH}$	-500	*	$\mu\text{A}$	* internally limited
Current	$I_{INH}$	-5	5	mA	$-0.3\text{ V} < V_I < 45\text{ V};$ $t < 1\text{ ms}$
<b>Temperatures</b>					
Junction temperature	$T_j$	-40	150	$^{\circ}\text{C}$	–
Storage temperature	$T_{stg}$	-50	150	$^{\circ}\text{C}$	–
<b>Thermal Resistances</b>					
Junction pin	$R_{thj-pin}$	–	30	K/W	measured to pin 5
Junction ambient <sup>1)</sup>	$R_{thja}$	–	179	K/W	zero airflow zero heat sink area

1) Worst case regarding peak temperature.

*Note: Maximum ratings are absolute ratings; exceeding any one of these values may cause irreversible damage to the integrated circuit.*

**Table 3 Operating Range**

Parameter	Symbol	Limit Values		Unit	Remarks
		Min.	Max.		
Input voltage	$V_I$	6.0	42	V	–
Inhibit input voltage	$V_{INH}$	-0.3	40	V	–
Junction temperature	$T_j$	-40	150	$^{\circ}\text{C}$	–

**Table 4 Electrical Characteristics**
 $6.2\text{ V} < V_I < 36\text{ V}; V_{\text{INH}} > V_{\text{INH, ON}}; -40\text{ }^\circ\text{C} < T_j < 150\text{ }^\circ\text{C};$  unless otherwise specified

Parameter	Symbol	Limit Values			Unit	Test Condition
		Min.	Typ.	Max.		
<b>Output</b>						
Output voltage	$V_Q$	4.85	5.0	5.15	V	$T_j = 25\text{ }^\circ\text{C};$ $1\text{ mA} < I_Q < 10\text{ mA}$
Output voltage	$V_Q$	4.8	5.0	5.20	V	$1\text{ mA} < I_Q < 10\text{ mA}$
Drop voltage	$V_{\text{dr}}$	0.6	0.8	1.1	V	$I_Q = 10\text{ mA}$
Output capacitor	$C_Q$	1	–	–	$\mu\text{F}$	$\text{ESR} \leq 10\ \Omega$ at 10 kHz
Output current	$I_Q$	15	–	70	mA	–
<b>Current Consumption</b>						
Quiescent current	$I_q$	–	60	100	$\mu\text{A}$	$I_Q < 10\text{ mA};$ $V_I = 13.5\text{ V}$
Quiescent current (stand-by)	$I_q$	–	–	1	$\mu\text{A}$	$V_{\text{INH}} < V_{\text{INH, OFF}};$ $T_j < 85\text{ }^\circ\text{C}$
Quiescent current (stand-by)	$I_q$	–	–	5	$\mu\text{A}$	$V_{\text{INH}} < V_{\text{INH, OFF}}$
<b>Regulator Performance</b>						
Load regulation	$\Delta V_Q$	–	5	10	mV	$0\text{ mA} < I_Q < 10\text{ mA};$ $V_I = 6.2\text{ V};$ $T_j \leq 85\text{ }^\circ\text{C}$
Line regulation	$\Delta V_Q$	–	5	10	mV	$I_Q = 5\text{ mA};$ $T_j \leq 85\text{ }^\circ\text{C}$
Power supply ripple rejection	$PSRR$	–	60	–	dB	$f_r = 100\text{ Hz};$ $V_r = 0.5\text{ Vpp}$
<b>Logic Inhibit Input</b>						
Inhibit ON-threshold	$V_{\text{INH, ON}}$	–	–	3.5	V	$V_Q \geq 4.8\text{ V}$
Inhibit OFF-threshold	$V_{\text{INH, OFF}}$	0.3	–	–	V	$V_Q \leq 0.8\text{ V}$
Inhibit input current H-state	$I_{\text{INH, ON}}$	–	10	15	$\mu\text{A}$	$V_{\text{INH}} = 5\text{ V}$
Inhibit input current L-state	$I_{\text{INH, OFF}}$	-2	0	2	$\mu\text{A}$	$V_{\text{INH}} = 0\text{ V}$

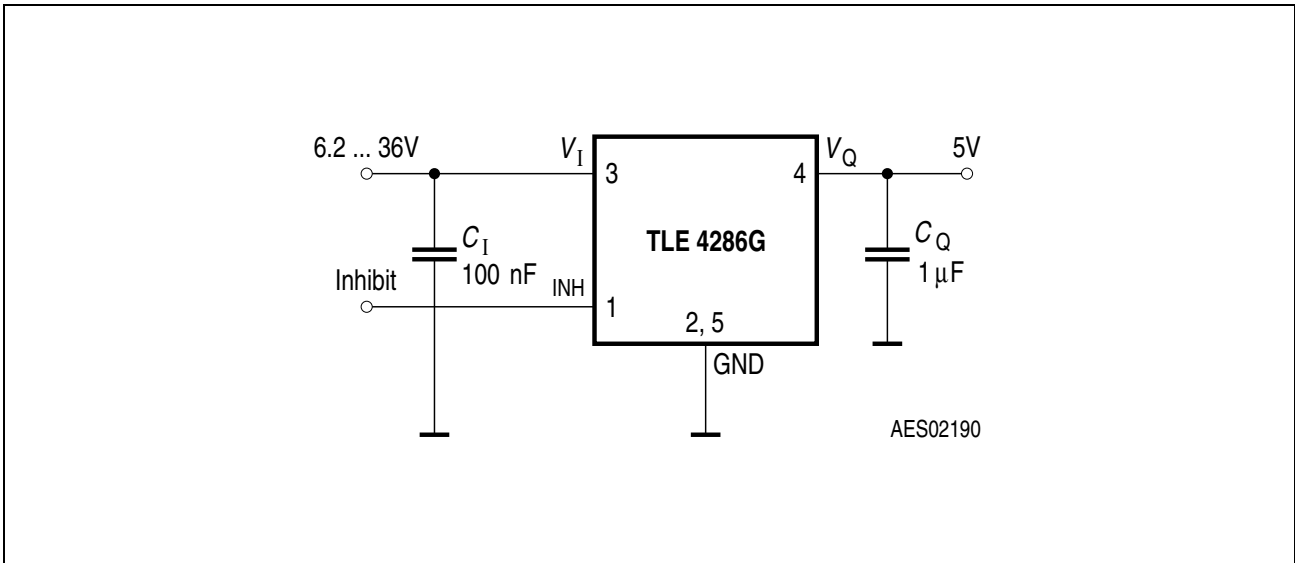

**Figure 3 Application Circuit**

Typical Performance Characteristics

Output Voltage  $V_Q$  versus Temperature  $T_j$

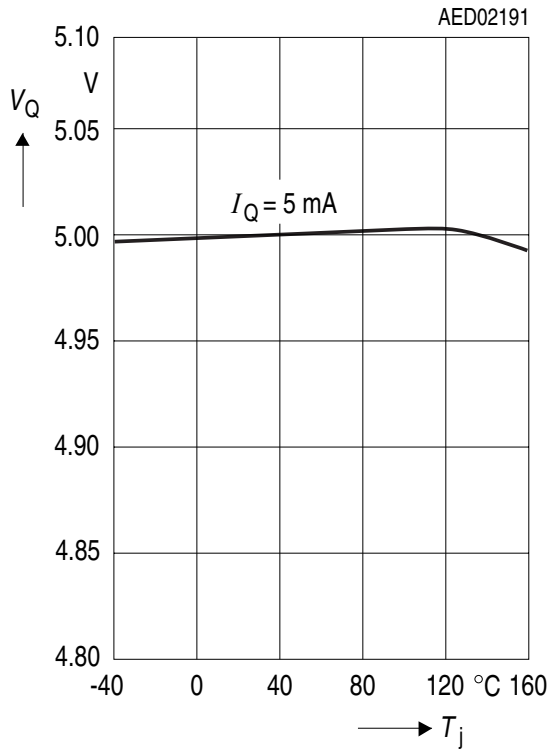

Output Voltage  $V_Q$  versus Output Current  $I_Q$

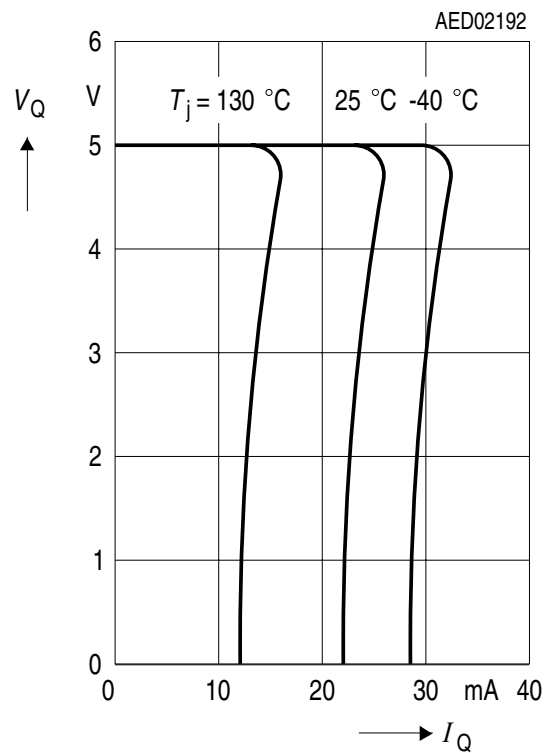

Current Consumption  $I_q$  versus Output Current  $I_Q$

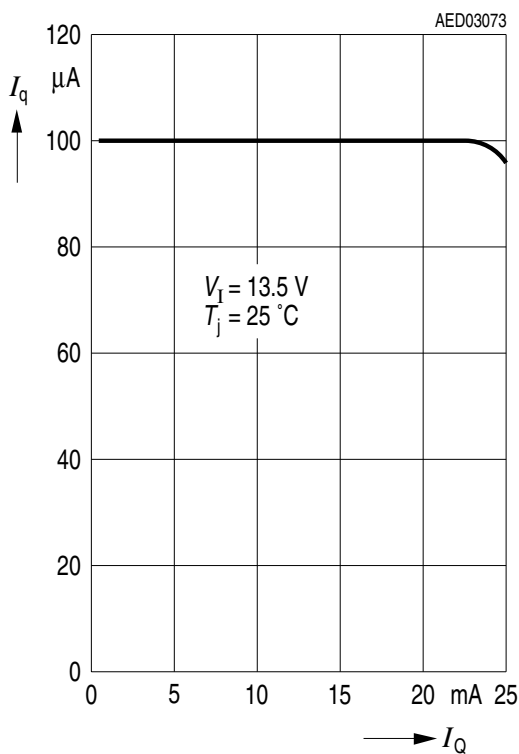

Current Consumption  $I_q$  versus Input Voltage  $V_I$

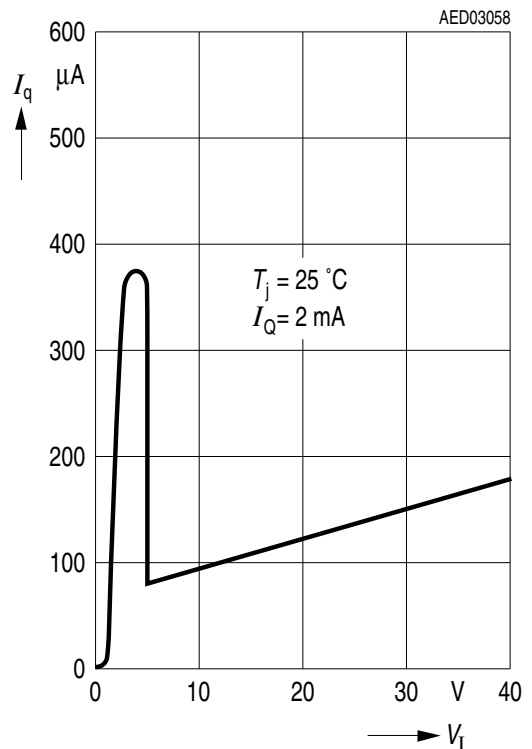

**Drop Voltage  $V_{dr}$  versus Output Current  $I_Q$**

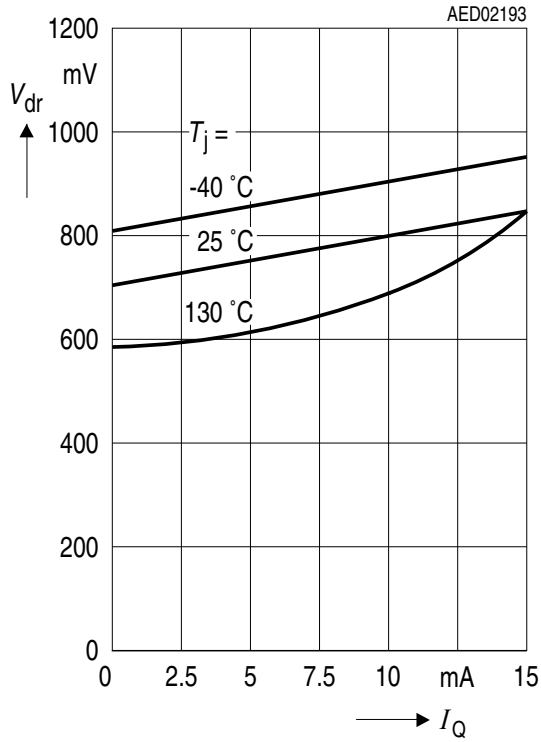

**Inhibit Voltage  $V_{INH}$  versus Inhibit Current  $I_{INH}$**

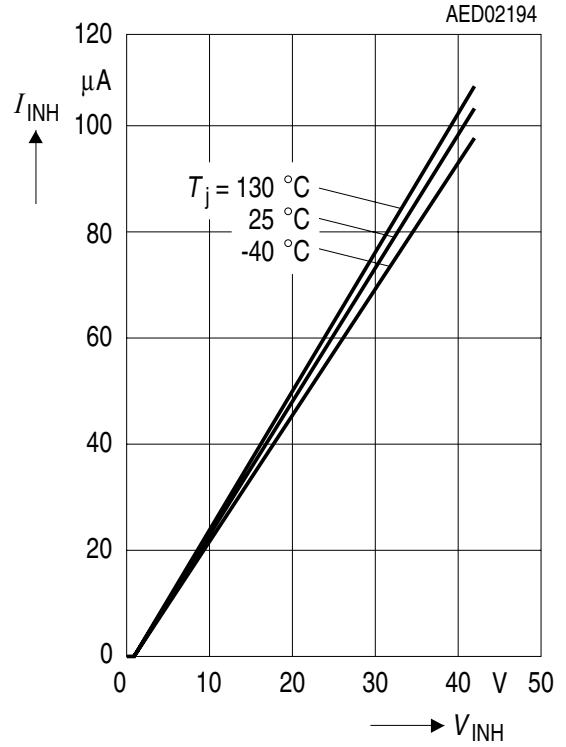

**Output Voltage  $V_Q$  versus Input Voltage  $V_I$**

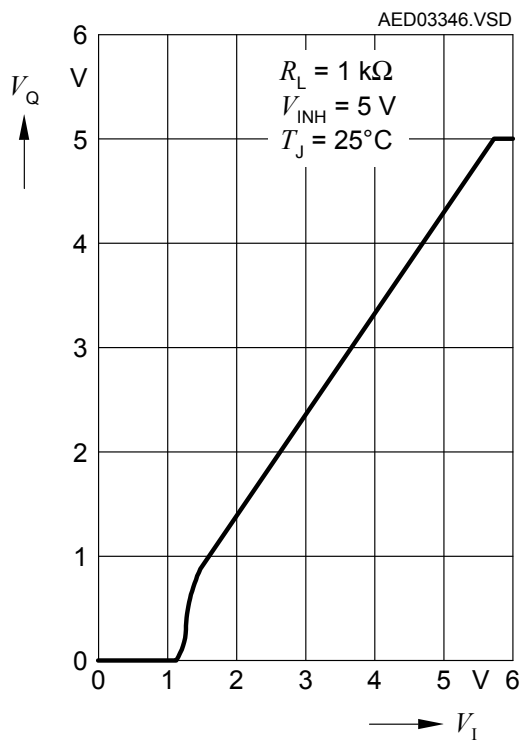



Package Outlines

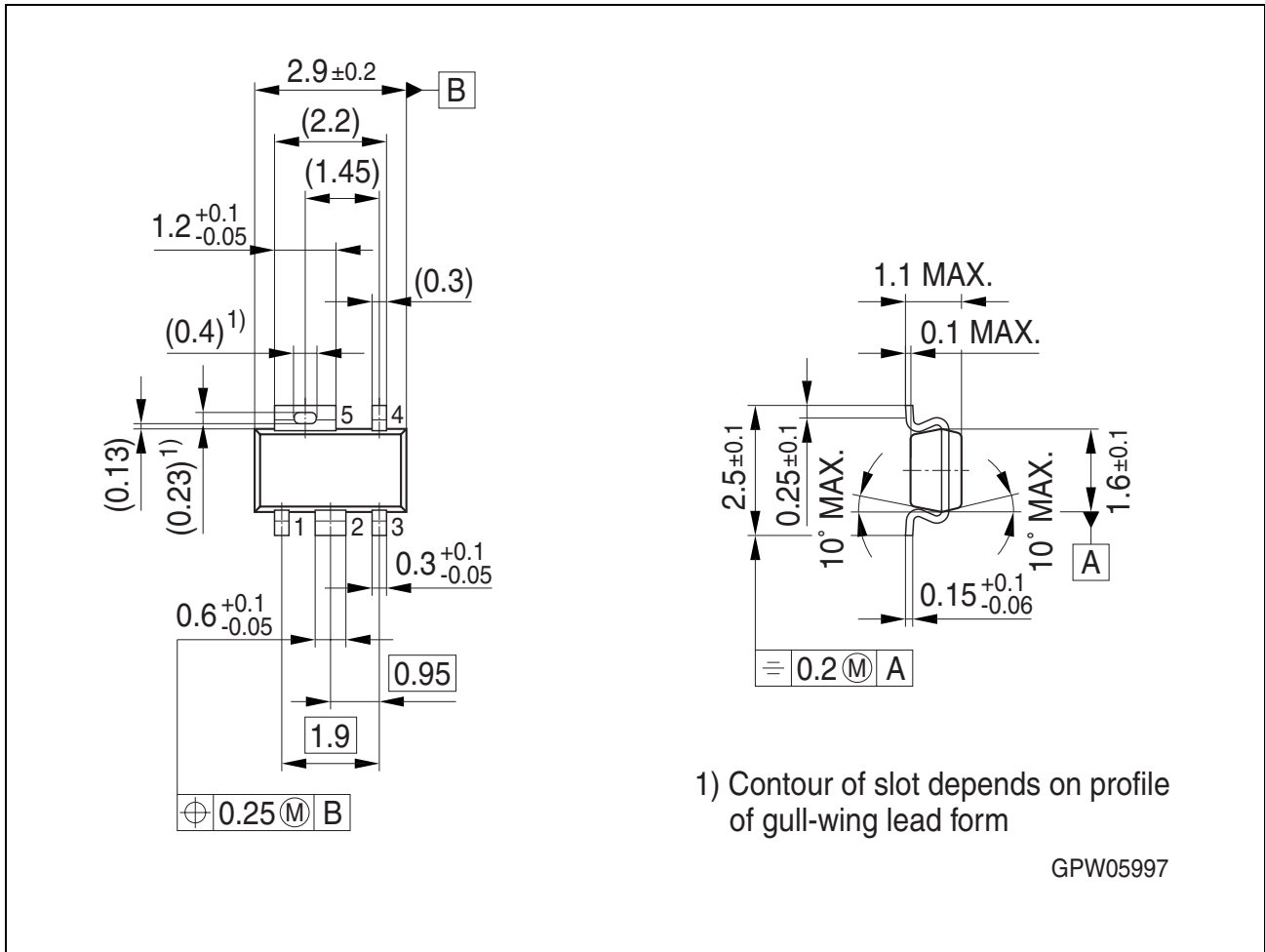

Figure 4 Outline PG-SCT-595-5

**Green Product** (RoHS compliant)

To meet the world-wide customer requirements for environmentally friendly products and to be compliant with government regulations the device is available as a green product. Green products are RoHS-Compliant (i.e Pb-free finish on leads and suitable for Pb-free soldering according to IPC/JEDEC J-STD-020).

You can find all of our packages, sorts of packing and others in our Infineon Internet Page "Products": <http://www.infineon.com/packages>.

SMD = Surface Mounted Device

Dimensions in mm

## Revision History

Version	Date	Changes
Rev. 2.3	2008-04-21	Initial version of RoHS-compliant derivate of TLE 4286 G. <b>Page 1</b> : AEC certified statement added. <b>Page 1</b> and <b>Page 9</b> : RoHS compliance statement and Green product feature added. <b>Page 1</b> and <b>Page 9</b> : Package changed to RoHS compliant version. <b>Page 1</b> : Marking information added. <b>Page 1</b> : Adapted description to values given on <b>Page 5</b> . Not a change of electrical characteristics. Legal Disclaimer updated
Rev. 2.2	2004-01-01	Final datasheet

**Edition 2008-04-21**

**Published by  
Infineon Technologies AG  
81726 Munich, Germany**

**© 2008 Infineon Technologies AG  
All Rights Reserved.**

### **Legal Disclaimer**

The information given in this document shall in no event be regarded as a guarantee of conditions or characteristics. With respect to any examples or hints given herein, any typical values stated herein and/or any information regarding the application of the device, Infineon Technologies hereby disclaims any and all warranties and liabilities of any kind, including without limitation, warranties of non-infringement of intellectual property rights of any third party.

### **Information**

For further information on technology, delivery terms and conditions and prices, please contact the nearest Infineon Technologies Office ([www.infineon.com](http://www.infineon.com)).

### **Warnings**

Due to technical requirements, components may contain dangerous substances. For information on the types in question, please contact the nearest Infineon Technologies Office.

Infineon Technologies components may be used in life-support devices or systems only with the express written approval of Infineon Technologies, if a failure of such components can reasonably be expected to cause the failure of that life-support device or system or to affect the safety or effectiveness of that device or system. Life support devices or systems are intended to be implanted in the human body or to support and/or maintain and sustain and/or protect human life. If they fail, it is reasonable to assume that the health of the user or other persons may be endangered.